

MADE IN
FRANCE



THE ESSENTIALS 2025

TOOLS SELECTION
FOR CONSTRUCTION SITES



BRICKLAYER



FACADE BUILDER



CONCRETE SLAB MAKER



TILER



DRYWALLER



EQUIPMENT

 **MONDELIN**

MONDELIN FRENCH MANUFACTURER



For over 72 years, Mondelin has been designing and manufacturing reliable, robust and innovative hand tools and equipment for the construction industry.

«We continue to develop our range of tools and to work on new innovations, while maintaining what is essential to us : the relationship that has always connected us with the craftsmen in their construction sites.»

TOOLS DEVELOPED WITH CRAFTSMEN

>> Mondelin was founded in 1952 by Roger Mondelin. From the beginning, Mondelin's founder went to construction sites to find solutions for craftsmen.

>> Since then, the Mondelin Research & Development team has been on construction site every day.

All Mondelin products are developed and tested in partnership with craftsmen before production.



INSPIRED BY YOUR CRAFT SITES



MONDELIN STANDS FOR INNOVATION

>> The Mondelin brand stands for reliability. The products are constantly improved in order to adapt them to current needs and requirements on the construction sites.

>> Developments for craftsmen, their comfort and performance.

Above all, innovation is achieved through a strong relationship between the craftsman, his needs and the Mondelin R&D team.

TOOLS MADE IN OUR FACTORY IN AMBIERLE (FRANCE)



Our factory integrates 3 strategic activities

>> Metal work

Manufacture of our Levpano®, spreader, knives, Ergolame®, stepladders, platforms, trestles...

>> Plastic work

Manufacture of our buckets and troughs, sieves, floats, Projoint®, plastic or bi-material handles...

>> Wood work

Manufacture of our wooden floats, foam floats, wooden handles, platforms...



OUR COMMITMENTS TO THE ENVIRONNEMENT

- >> French manufacturing highlighted to limit transport and develop local employment.
- >> Our tools are designed for maximum durability. Moreover, our equipment is repairable and a large number of spare parts are available.
- >> We are PEFC and FSC™ certified for sustainable and responsible forest management.
Only products identified as such in this catalog are PEFC and FSC™ certified.
- >> 72% of our plastic raw material purchases come from recycled materials.
- >> We have invested in a machine to manufacture our own cardboard boxes, thus limiting the amount of plastic packaging we use.

DISCOVER US

>> Watch the video “The history of Mondelin, 70 years working for craftsmen” and get to the heart of our company by discovering what makes our DNA, more than 70 years after its creation.



AND FOLLOW OUR NEWS ON :



www.mondelin.fr

CONTENT



BRICKLAYER.....3-6



FACADE BUILDER.....7-8



CONCRETE SLAB MAKER.9-12



TILER.....13-16



DRYWALLER.....17-27



EQUIPMENT.....28-35



MOB FORGED TOOLS.....36-42

PROCHOK® FLEXIBLE TUB

Ref : 343450
EAN : 3479133434506



NEW 2024

- >> Black Prochok® material combines strength and lightness
- >> For transporting cement, gravel, earth, spoil... to construction sites.

NEW DESIGN

- >> Reinforcing ribs for added strength
- >> Large and comfortable handles
- >> Graduated



40 L

COLOR FLEXIBLE PLASTIC TUB



- >> Ultra-flexible, lightweight plastic

NEW DESIGN

- >> Reinforcing ribs for added strength
- >> Large and comfortable handles
- >> Graduated



40 L

MONDELIN INNOVATION

- >> IML (In Mould Labelling): molded in the mass, the label cannot be removed.
- >> No label waste on site.
- >> Perfectly recyclable.



NEW 2025

	40 L	Orange	Yellow	Red	Blue
Ref		342460	342470	342510	342540
EAN 347913+		3424606	3424705	3425108	3425405

PROCHOK® MASONS TROUGH



Capacity	12 L	25 L	35 L
Ref	343510	343520	343530
EAN 347913+	3435107	3435206	3435305

PROCHOK® BUCKET



- >> Thick and flexible
- >> Withstands extreme worksite conditions
- >> With IML



12 L

NEW 2025

	Black Prochok®		NEW : Orange Prochok®
Handle	Ø 6,3 mm	Ø 6,8 mm	Ø 5,3mm with handle
Ref	341140	341120	341151
EAN 347913+	3411408	3411200	3411514

PLASTIC BUCKET

Ref : 341080
EAN : 3479133410807



11 L

- >> Lightweight
- >> Handle : Ø 5,3 mm

COLOR PLASTIC BUCKET



- >> 4 colors available
- >> Handle : Ø 5,3 mm



	11 L	Orange	Blue	Yellow	Red
Ref		341220	341240	341230	341210
EAN 347913+		3412207	3412405	3412306	3412108





SUPERCHOK® PLASTIC SIEVE



- >> Optimum screen tension: continuous welding along the entire screen base and unique assembly process
- >> Resistant polystyrene frame : excellent impact resistance
- >> Wide edge for a good grip in the hand



STACKABLE



FITS PERFECTLY ON OUR NEW FLEXIBLE TUBS



N°	6	8	10	12	14
Ref	301860	301880	301900	301920	301940
EAN 347913+	3018607	3018805	3019000	3019208	3019406

BLACK FLOAT

>> Made from recycled polystyrene



Dim - cm	28 x 41	26 x 35	18 x 27	Pointed 18 x 27
Ref	313100	313110	313120	313132
EAN 347913+	3131009	3131108	3131207	3131320

ABS FLOAT

>> ABS tray, for excellent resistance to impact and abrasion
>> For intensive use



Dim - cm	28 x 41	26 x 35	18 x 27	Pointed 18 x 27
Ref	311300	311310	311320	311332
EAN 347913+	3113005	3113104	3113203	3113326

FOLDING TRESTLE

Ref : 113000
EAN : 3479131130004



- >> Wooden beam to protect the installed part
- >> Feet locked in open or closed position



ADJUSTABLE FOLDING TRESTLE

Ref : 113010
EAN : 3479131130103



- >> Wooden beam to protect the deposited material
- >> Lock with safety pins
- >> Adjustable height: 80 to 130 cm





ALUMINIUM LEVELLING RULE



- >> Ribbed profile for greater resistance
- >> Handles integrated into the profile, not extending beyond it
- >> Very precise vials: Adjustment and quality control in our factory, through a light sensor.
- >> Mounting of the vials: Impact resistant ABS plastic, glued and screwed in place
- >> Heavy duty, high quality aluminium, 22 x 100 mm

Dim	1,50 m	2 m	2,50 m
Ref	351615	351620	351625
EAN 347913+	3516158	3516202	3516257

ALUMINIUM ANGLE SQUARE

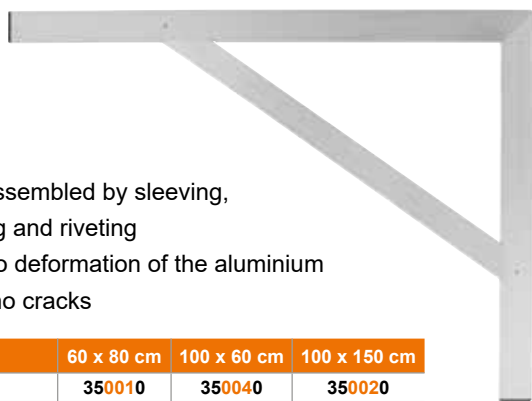

- >> Assembled by sleeving, gluing and riveting
- >> No deformation of the aluminium and no cracks

Dim	60 x 80 cm	100 x 60 cm	100 x 150 cm
Ref	350010	350040	350020
EAN 347913+	3500102	3500409	3500201

ALUMINIUM MASON'S RULE

- >> High quality impact resistant aluminium
- >> With end caps for maximum protection, the mortar can not get inside.
- >> 1 reinforcement



Dim	2 m	3 m	4 m
Ref	351200	351300	351400
EAN 347913+	3512006	3513003	3514000

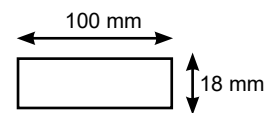

TRAPEZOIDAL LEVEL

Ref : 872600
EAN : 3479138726002



- >> Solid cast aluminium body
- >> Machined sole
- >> 1 horizontal vial and 1 vertical vial

MAGNETIC TAPE MEASURE

Ref : 876358
EAN : 3479138763588

5 m x 25 mm

- >> Resistant bi-material case
- >> Manganese 65Mn alloy steel ribbon protected by a nylon film
- >> Magnetic hook



LONG TAPE MEASURE

Ref : 878138
EAN : 3479138781384

30 m x 15 mm

- >> Fiberglass ribbon, with metal hook
- >> Two-side printing
- >> Class II
- >> Anti-shock corners



TAPE MEASURE - BLOCK'UP

Ref : 876458
EAN : 3479138764585

5 m x 25 mm

- >> Automatic lock when opened. Button to release the tape
- >> Two-side printing, vertical and horizontal reading



DOUBLE POCKET WITH BELT

Ref : 805000
EAN : 3479138050008



- >> In soft, riveted leather for a long lifespan
- >> 11 pockets
- >> Central pocket in rigid leather to put a measurement
- >> Rigid leather hammer loop

NEON POLYPROPYLENE BRAID

- >> Polypropylene.
- >> Pink fluorescent.



Wire Ø	1,5 mm	2,5 mm
Ref	823110	823120
EAN 347913+	8231100	8231209

CARTRIDGE GUN

Ref : 153720
EAN : 3479131537209



- >> For cartridges up to 310 ml
- >> Steel case
- >> 2-axis aluminium handle

CHALK LINE REEL

Ref : 815010
EAN : 3479138150104



- >> Polyester / cotton chalk line, 30 m
- >> Ø 1,5 mm



BLUE CHALK LINE POWDER

- BLUE**
- >> High visibility
 - >> Excellent trace on all surfaces

Capacity	200 g	400 g
Ref	814180	814360
EAN 347913+	8141805	8143601



ORANGE CHALK LINE POWDER

Ref : 814220
EAN : 3479138142208

- ORANGE FLUORESCENCE COLOR**
- >> Fluorescent for optimum visibility
 - >> Capacity : 200 g



CURB LAYING

Ref : 303110
EAN : 3479133031101



- >> Facilitates handling and installation of curbs
- >> Adjustable from 0,5 to 1 m, in steps of 10 cm
- >> Automatic lock and anti-tip
- >> Suspension hook

HELICAL MIXING PADDLE

Ref : 881030
EAN : 3479138810305



- >> Helical Ø 90 mm
- >> For thick material with high viscosity
- >> For mixtures of 4 to 10 kg



WOODEN FLOAT WITH FOAM SOLE



- >> For a traditional roughcast finish
- >> With a yellow sponge made of polyurethane
- >> Oval ergonomic handle
- >> Traditional double dovetail handle mounting



REPLACEMENT BOARDS

Dim - cm	18 x 33	14 x 25	Dim - cm	18 x 33	14 x 25
Ref	314157	314167	Ref	314357	314367
EAN 347913+	3141572	3141671	EAN 347913+	3143576	3143675

MONOBLOC EXPANDED POLYSTYRENE FLOAT

- >> For smoothing concrete
- >> For a smooth and even surface

Dim - cm	15 x 20	27 x 15
Ref	316200	316210
EAN 347913+	3162003	3162102



MONOBLOC FOAM SOLE FLOAT FOR FACADE BUILDER

Ref : 321320
EAN : 3479133213200



14 x 29 cm

- >> For a fine finish on plasters: foam base with small cells



COATING KNIFE

0,6 mm



- >> Hardened stainless steel blade
- >> Aluminium support
- >> Wooden handle



Dim - cm	50 cm	60 cm
Ref	224500	224600
EAN 347913+	2245004	2246001

SCAPING FLOAT



- >> For making coatings with a scraped finish
- >> Interchangeable pressed metal connector
- >> Wooden handle

	240 teeth 15 mm - 14 x 24 cm	480 teeth 8 mm - 15 x 25 cm
Ref	321200	321210
EAN 347913+	3212005	3212104

Replacement board	240 teeth 15 mm - 14 x 24 cm	480 teeth 8 mm - 15 x 25 cm
Ref	321201	321211
EAN 347913+	3212012	3212111



FOAM FLOAT ECOKIT

Ref : 315168
EAN : 3479133151687



SCRAPER FLOAT ECOKIT

Ref : 321218
EAN : 3479133212180



>> KIT
1 foam float
+ 6 spare trays

Dim : 14 x 25 cm



>> KIT
1 scraper float
+ 9 spare trays

Dim : 15 x 25 cm
480 teeth of 8 mm

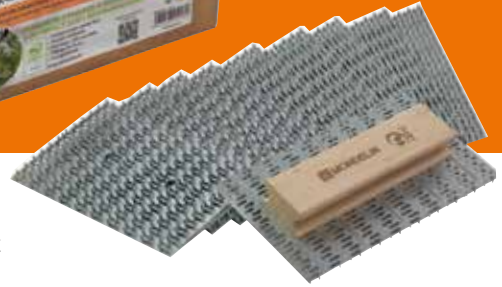

Spare tray =

- >> Less waste
- >> Space saving during transport
- >> More economical

FACEDE BUILDER



MONDELIN IS COMMITTED TO REDUCE ITS IMPACT ON THE ENVIRONMENT

>> Reusable handle = Less waste generated

>> Eco-designed packaging

- 100% recyclable cardboard packaging, with no plastic parts;
- A kit that is easy to carry, thanks to the protruding handle;
- Packaging perfectly adapted to the product: no loss of material;
- Packaging manufactured directly in our factory: no transport.

>> Products made in France, manufactured in Ambierle

Our floats are entirely manufactured in our factory, as well as the cardboard packaging.

>> PEFC certified wood: for the promotion of sustainably managed forests

>> Find in video the actions of Mondelin to limit its impact on the environment:



WATCH THE VIDEO :





CONCRETE SMOOTHING SPREADER

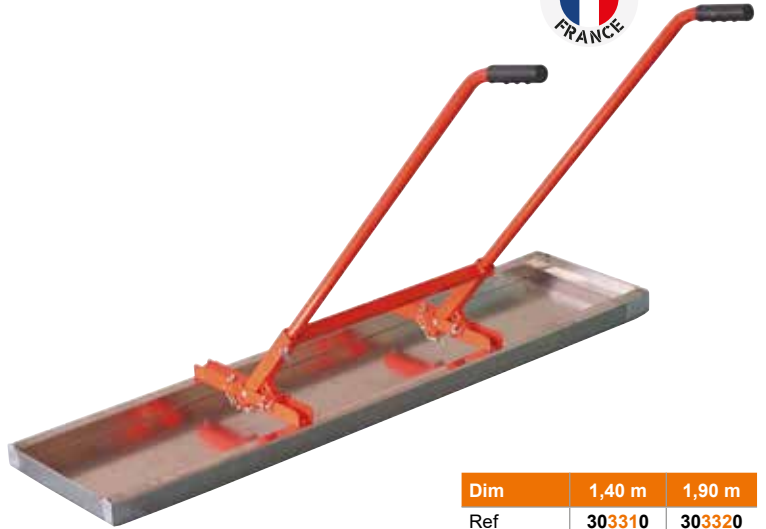

Dim	1,40 m	1,90 m
Ref	303310	303320
EAN 347913+	3033105	3033204

- >> Allows you to spread concrete while adjusting flatness, pre-smoothing and bringing up laitance.
- >> The aluminium plate can be weighted to adapt smoothing to the consistency of the concrete
- >> Raised edges to avoid catching on concrete
- >> Height-adjustable handles for improved ergonomoy

CONCRETE SMOOTHING MACHINE

Ref : 226910
EAN : 3479132269109

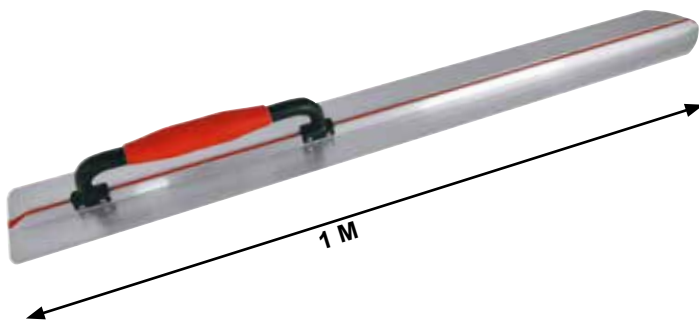

- >> Use in addition to or instead of smoothing spreader for smaller surfaces
- >> Aluminum profile, ogival shape

FORMWORK SCRAPER



- >> Screwed blade
 - >> Handle sold separately :
- Ref. 635900001

Dim - cm	30 cm	10 cm
Ref	301310	301410
EAN 347913+	3013107	3014104

CEMENT EDGER



- >> For rounding the corners of concrete structures
- >> Height: 9 cm

Material	Plastic	Cast iron
Ref	302200	302210
EAN 347913+	3022000	3022109

ARTICULATED ALUMINIUM SLAB SMOOTHER

Smoother with integrated joint that allows the blade to be tilted simply by turning the handle.

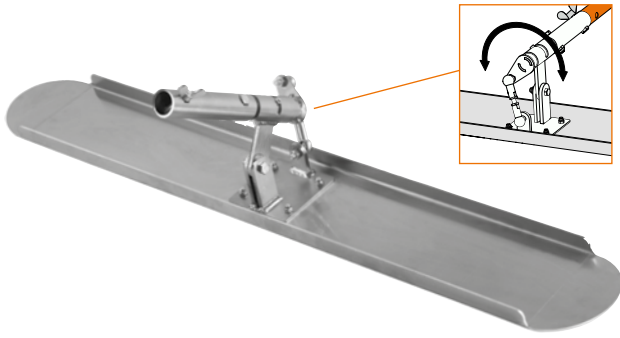

- >> For smoothing concrete slabs. Closes the surface of concrete as it begins to set, ensuring a flat surface without leaving a trace.
- >> Use with a pole so you don't have to walk on concrete
- >> Aluminium plate that does not sink into the concrete
- >> Double-rounded anti-tracking blade, with slightly raised tips to prevent streaking when the blade is tilted.
- >> Edges folded lengthwise to prevent material from riding up on the blade
- >> A robust, simple and efficient zinc-plated steel joint, protected from corrosion

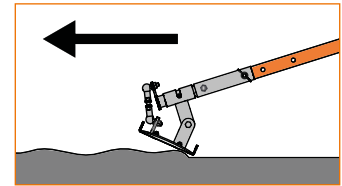
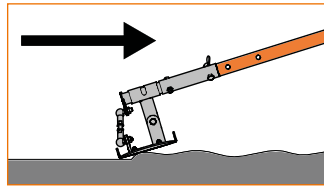

- 2 BLADE SIZES**
- >> 2 lengths : 100 cm and 150 cm
 - >> Width : 14 cm



INTERLOCKING POLE

- >> For smoothing concrete over long lengths without damaging it, by combining several poles with each other.

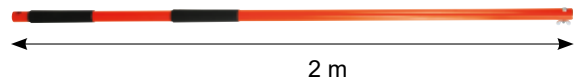

	Articulated smoother 100 cm	Articulated smoother 150 cm	Interlocking pole of 2 m
Ref	304600	304800	304010
EAN 347913+	3046006	3048000	3040103



SET OF ARTICULATED SMOOTHER + 3 POLES IN TRANSPORT BAG

- >> Smoother can be transported with up to 4 interlocking poles
- >> The blade is perfectly protected
- >> Fits both 100 cm and 150 cm long blades
- >> Transport and storage are simplified



	Smoother 100 cm + 3 poles of 2m in a transport bag	Smoother 150 cm + 3 poles of 2m in a transport bag
Ref	304610	304810
EAN 347913+	3046105	3048109

2 IN 1 FLOOR SMOOTHER



>> 2 in 1: Allows slabs to be smoothed with a pole or by hand without the need to change tools

- >> Stainless steel blade 70 x 12 cm
- >> Tilting handle with soft grip

Use with a pole



Manual use



2 models :

Pointed shape

- >> Heels with anti-fingerprint rounded corners
- >> Pointed tip, ideal for corners and difficult access

Double-rounded shape

- >> Double rounded: does not leave traces
- >> For a perfect finish



1 mm



TELESCOPIC POLE

- >> Light and resistant aluminium tube
- >> Ergonomic pole with two soft covers

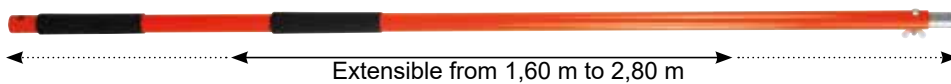

	Pointed smoother 70 x 12 cm	Double-rounded smoother 70 x 12 cm	Telescopic pole
Ref	303201	303211	304000
EAN 347913+	3032016	3032115	3040004



CONCRETE SLAB MAKER

FLOOR SPREADER



1 mm

- >> One-hand screed smoothing trowel
- >> Pointed to end smooth the corners
- >> Hardened stainless steel blade
- >> Rounded heel angles
- >> Aluminium profile frame

Dim - cm	45 x 12	55 x 12
Ref	233221	233231
EAN 347913+	2332216	2332315



FLOOR SMOOTHER DOUBLE-ROUNDED BLADE



Ref : 234801
EAN : 3479132348019

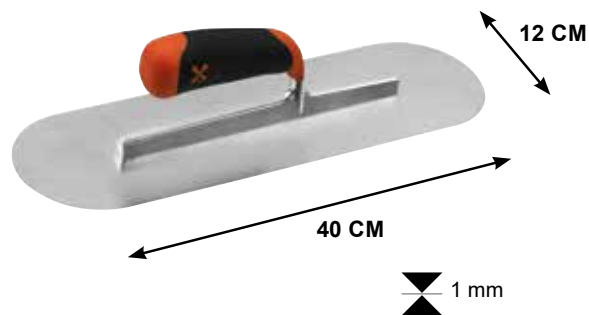

For finishing work or small surfaces

- >> Double rounded shape for smoothing without leaving traces
- >> Stainless steel blade
- >> Aluminium frame
- >> Bi-material handle

BUBBLE RELEASE BAR



- >> To avoid bubbles on screed
- >> Aluminum for a lighter tool
- >> 4 adjustable heights : 75, 80, 85 et 90 cm



Dim	1,50 m	2 m
Ref	303250	303260
EAN 347913+	3032504	3032603



10 TRIPODS LEVEL MARKERS

Ref : 303340
EAN : 3479133033402



- >> For adjusting the thickness of liquid screeds
- >> Quick, precise adjustment from 0 to 16.5 cm
- >> Staggered at approximately 1.50 m intervals



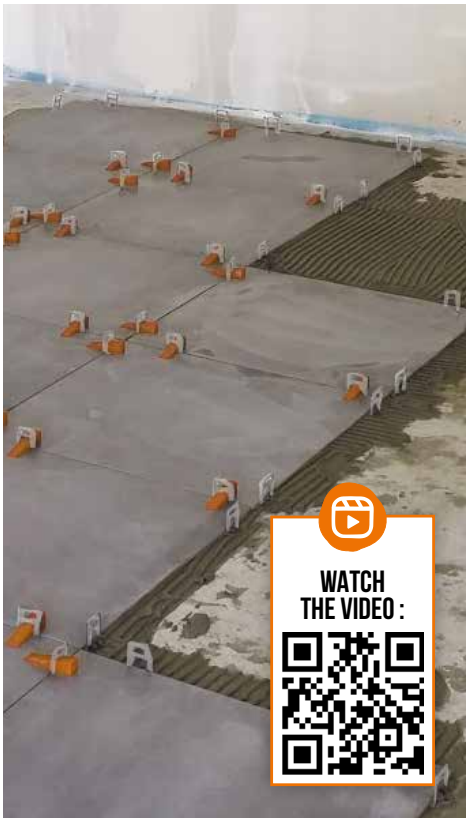

WATCH THE VIDEO :

TILE LEVELS KIT

Ref : 151610
EAN : 3479131516105



- This kit contains :
- 100 x 2 mm self-leveling bases for levels
 - 100 reusable wedges
 - 1 pair of pliers
 - 1 transport bucket

- >> This levelling system ensures that the tiles are perfectly level when laid.
- >> Prevents any unevenness from forming during laying or setting
- >> Ideal for laying large tiles
- >> Can be used for horizontal and vertical installation and for tiles from 3 to 16 mm thick

SLAB GRABBER



- >> Allows the slabs to be deposited directly and precisely in their location, in complete safety
- >> Adjustment every 16 mm to adapt to the size of the slab
- >> 2 sizes :
 - Plate length between 500 and 700 mm:
 - > Payload of 40 kg – 1,5 kg
 - Plate length between 300 and 700 mm:
 - > Payload from 50 kg – 2,9 kg

Dim - cm	30 to 50	30 to 70
Ref	153000	153020
EAN	1530002	1530200
347913+		



DOUBLE SUCTION CUP

Ref : 153690
EAN : 3479131536905

- >> Allows you to lay and remove tiles, panels and windows from non-porous surfaces
- >> Load capacity: 80 kg
- >> Double rubber transport suction cup and aluminium base



GLUE SPREADER -45° BENT BLADE

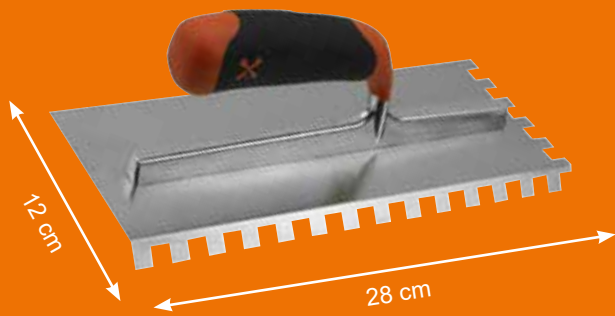

0,6 mm

>> Blade bent at 45° for glue application without breaking the wrist. Limits MSD.

>> Also provides easier access to tight spaces in renovation projects (e.g. under radiators)

>> Stainless steel blade

>> Bi-material handle



Teeth	Square 10 x 10 mm	1/2 round
Ref	236661	236681
EAN 347913+	2366617	2362815



GLUE SPREADER

28 x 12 cm

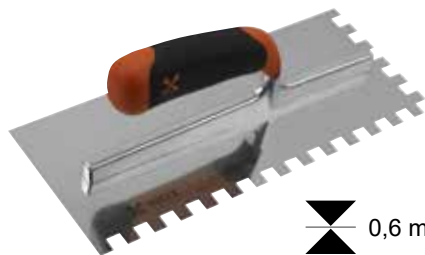

0,6 mm

>> Stainless steel blade toothed on 2 sides

>> Ergonomic bimaterial handle

>> Aluminium frame

Teeth-mm	Square 6 x 6	Square 8 x 8	Square 10 x 10	Square 12 x 12	Square 15 x 15
Ref	234641	234651	234661	234691	234701
EAN 347913+	2346411	2346510	2346619	2346916	2347012

EARTHENWARE COATING SPREADER

Ref : 161300
EAN : 3479133024300



>> For finishing tile joints
>> Ergonomic polystyrene handle for better working comfort



JOINT BAG

Ref : 302430
EAN : 3479133024301

>> Bag with PVC coating on both sides
>> Special attachment for tiles



JOINING SPREADER

Ref : 152710
EAN : 3479131527101



>> For grouting
>> One-piece polystyrene tray and handle
>> Black rubber sole, thickness: 8 mm
>> 29 x 14 cm

CLEANING SPREADER

WITH YELLOW SPONGE
Ref : 152760
EAN : 3479131527606

>> Thickness of the foam: 30 mm
>> 29 x 14 cm

WITH POLYURETHAN SPONGE
Ref : 152840
EAN : 3479131528405

>> Thickness of the foam: 40 mm
>> Plaid patterned foam for more efficient cleaning
>> 34 x 17 cm

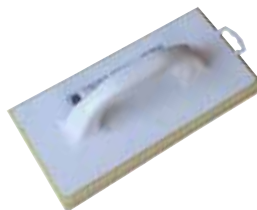

TILER

kit to simplify grouting and cleaning of tiled surfaces

KIT CONTENTS :

- >> 30L plastic container on wheels
- >> Capacity of 13 L
- >> Removable plastic grid
- >> Set of 3 cleaning rollers
- >> 1 jointing spreader
- >> 1 cleaning spreader



- >> 4 wheels with brakes



- >> System to prevent the water from overflowing during transport.



- >> 3 rollers allow to wring out spreader horizontally or vertically during cleaning.



- >> Easy cleaning: Smooth surface + spill protection and removable rollers



- >> 2 spouts to prevent splashing



KNEEPADS

Ref : 154140
EAN : 3479131541404



Complies with standard EN 14404 / PPE type 1

FOR PROFESSIONAL USE

- >> Optimal padding for intensive use
- >> Shell in a fixed position
- >> Adapts to your movements on flat or uneven floors
- >> Transparent shell does not leave marks on the tiles



CROSS SHAPE

- >> Cross tie for added comfort



FASTENING WITH CLIPS

- >> Elastic adjustable clips: more durable and higher quality than Velcro. Also, there is less risk of injury.
- >> Does not adjust unintentionally.
- >> Easy Removal: Can be easily pulled over the foot.



HANDLING TROLLEY

Ref : 114320
EAN : 3479131143202



Swift

Ideal for transporting tiles or glue bag, but also suitable for many other types of handling

- >> Non-slip platform: 400 x 400 mm
- >> Very mobile: 4 wheels 360°
- >> Brake on each wheel
- >> Non-slip plywood board with a thickness of 18 mm
- >> Rounded corners and edges
- >> Easy transport thanks to a handle
- >> Light : 3,2 kg



40 X 40 CM



BI-MATERIAL ERGOLAME®

An ergonomic bi-material handle



NEW 2024

- >> Innovative, ergonomic bimaterial handle with 2 soft grip strips
- >> High-quality stainless steel blade bent to combine straightness and flexibility
- >> Easily interchangeable blade thanks to a key in the handle
- >> 2 blade flexibility :
 - Rigid for smoothing plaster, clamping and making joint strips
 - Flexible for raking, finishing or decorative plasters
- >> Blades are protected by a very easily repositionable blade guard
- >> 6 dimensions for all your work



WATCH THE VIDEO :

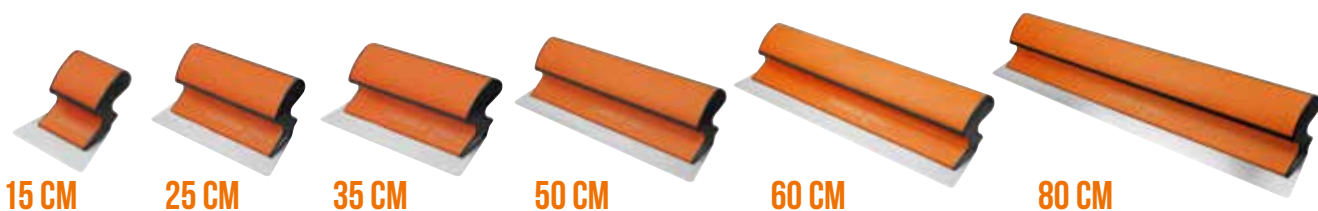

RIGID blade - thickness 0.6 mm

Dim - cm	15	25	35	50	60	80
Ref	227500	227505	227510	227520	227530	227540
EAN 347913+	2275001	2275056	2275100	2275209	2275308	2275407

FLEXIBLE blade - thickness 0.3 mm

Dim - cm	15	25	35	50	60	80
Ref	227600	227605	227610	227620	227630	227640
EAN 347913+	2276008	2276053	2276107	2276206	2276305	2276404

BIMATERIAL POLE FOR ERGOLAME®

Ref : 227450
EAN : 3479132274509

- >> Lightweight aluminum pole with 2 soft grips for a comfortable grip
- >> Swivel head for quick and easy adjustment

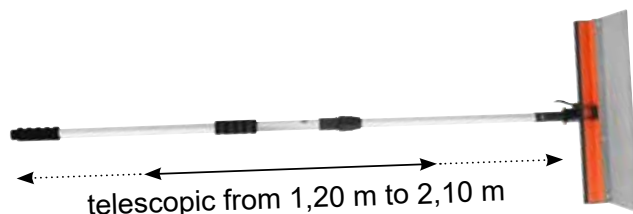

PLASTER ROLLERS

- >> For fast, easy plaster application
- >> Enables fine, even plaster thickness to be applied
- >> Fits on pole



Complete roller	8cm	18cm	25cm
Ref	867010	867020	867030
EAN 347913+	8670107	8670206	8670305

Replacement sleeve	18cm	25cm
Ref	867040	867050
EAN 347913+	8670404	8670503

ERGOLAME® TEXTILE CASE

To protect and transport your Ergolame®



- >> Integrated blade guards to extend Ergolame® blade life
- >> Each element is perfectly held in place by a hook-and-loop fastening system
- >> Easy transport: Allows you to carry all your Ergolame® in one go
- >> 2 handles + 1 reinforced strap
- >> Lightweight, washable fabric



Ref. of the empty textile case : 227300

4 TEXTILES CASES, FULLY EQUIPPED

ERGOLAME® TEXTILE CASE JOINT TAPE

Ref : 227310
EAN : 3479132273106

- >> 2 Ergolame® rigid blade 25 cm + 35 cm
- >> 1 Ergolame® 50 cm flexible blade
- >> 1 coating roller of 8 cm
- >> 1 pole 75-135 cm
- >> 2 bi-material coating knives 127 mm + 152 mm
- >> Textile case



ERGOLAME® TEXTILE CASE RAKING

Ref : 227320
EAN : 3479132273205

- >> 5 Ergolame® flexible blade 15 cm + 25 cm + 35 cm + 50 cm + 80 cm
- >> 1 bimaterial coating knife 152 mm
- >> 1 coating roller of 18 cm
- >> 1 pole 75-135 cm
- >> 1 Heliss multifunction knife
- >> Textile case



ERGOLAME® TEXTILE CASE ESSENTIAL RAKING

Ref : 227330
EAN : 3479132273304

- >> 4 Ergolame® flexible blade 25 cm + 35 cm + 50 cm + 60 cm
- >> 1 bimaterial coating knife 152 mm
- >> 1 coating roller of 18 cm
- >> 1 Heliss multifunction knife
- >> Textile case



ERGOLAME® TEXTILE CASE DRYWALLER

Ref : 227340
EAN : 3479132273403

- >> 2 Ergolame® rigid blade 15 cm + 25 cm
- >> 1 Ergolame® flexible blade 35 cm + 60 cm
- >> 1 bimaterial coating knife 152 mm
- >> 1 pole 75-135 cm
- >> 1 Heliss multifunction knife
- >> Textile case



COATING KNIVES



- >> High-quality tempered stainless steel blade with perfect cutting edge
- >> Bimaterial handle
- >> Designed for professional handling
- >> Handle for right- and left-handed use



Dim - cm	10	12	16	20	24	30
Ref	223300	223320	223360	223400	223440	223490
EAN 347913+	2233001	2233209	2233605	2234008	2234404	2234909

HELISS MULTIFUNCTION KNIFE

Ref : 221000
EAN : 3479132210002



**NEW
2024**



Hélist

4 BLADES AVAILABLE

- 3 cm bevelled scraper blade, 1 mm thick
- 3 cm blade for smoothing plaster, 0.7 mm thick
- 2 cm blade for smoothing plaster, 0.7 mm thick
- 1 pointed blade for angles under 90°, 0.7 mm thick

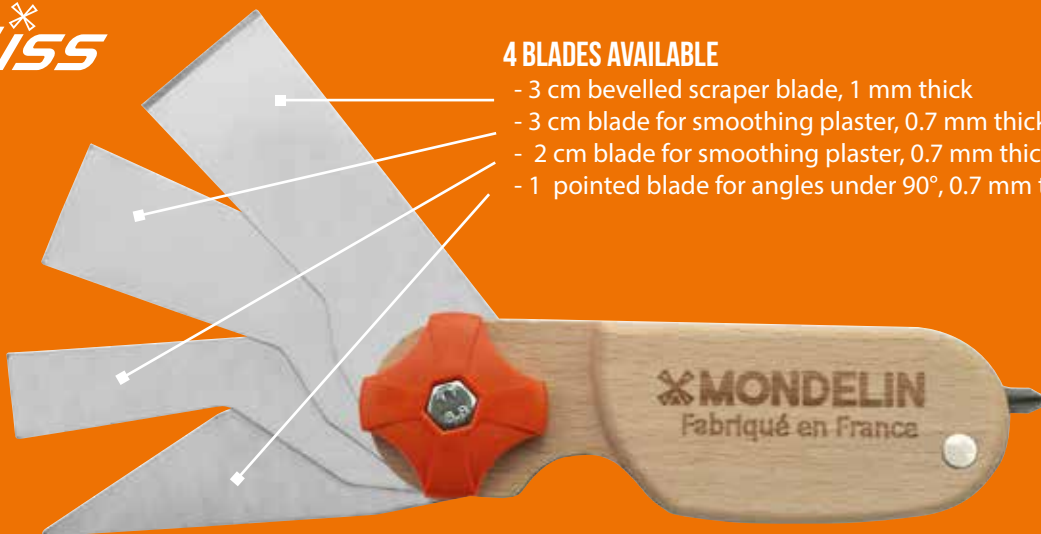

PH2

- >> 1 tool for all your finishing needs
- >> Smooths narrow spaces such as door and window frames
- >> Stainless steel blades
- >> PEFC beech handle with varnish for easy cleaning



BUCKET SCOOP KNIFE

Ref : 224100

EAN : 3479132241006



**NEW
2025**

- >> Tool for scraping plaster pots
- >> Saves time, reduces waste
- >> Rigid folded stainless steel blade, 0.5 mm thick
- >> Bimaterial handle

 0,5 mm



SET OF AMERICAN KNIVES

- >> Case with high-quality washable lining
- >> 8 slots for 7 American knives (31, 38, 51, 76, 102, 127, and 152 mm) + 1 multi-purpose knife



>> Blade guard flap



>> Easy clip closure



>> With handle



>> Dimensions for easy knife storage

SET OF BIMATERIAL AMERICAN KNIVES

Ref : 221680

EAN : 3479132216806



X7

STAINLESS
STEEL

+



X1

STAINLESS
STEEL

CASE OF NYLON AMERICAN KNIVES

Ref : 221830

EAN : 3479132218305



X7

STAINLESS
STEEL

+



X1

STEEL

SPREADER SPECIAL JOINT TAPES



Ref : **234561**

EAN : 3479132345612

- >> Spreader with a concave stainless steel blade to make it easier to load plaster when making joint strips.
- >> Controls the thickness of plaster applied
- >> Rounded corners in order to work without leaving traces
- >> Bimaterial handle
- >> Aluminum frame
- >> Dim : 28 x 12 cm

 0,7 mm



CONCAVE BLADE

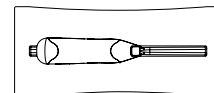

SPREADER WITH BIMATERIAL HANDLE



- >> Ergonomic bimaterial handle
- >> Lightweight cast aluminum frame
- >> Hardened stainless steel blade
- >> 0.6 mm blade thickness, ideal compromise between rigidity and flexibility
- >> Bevelled blade : allows excellent tightening and smoothing of coatings
- >> Curved blade : blade helps to lay and finish the joint.



 0,6 mm



Dim - cm	28 x 12	28 x 12 beveled	35 x 10 beveled	28 x 12 curved
Ref	234521	234531	234541	234551
EAN 347913+	2345216	2345315	2345414	2345513



SOFT TROWEL FOR INSIDE CORNER



Ref : **502180**

EAN : 3479135021803

- >> Flexible stainless steel blade of 0.4mm
- >> Ideal for plasterers: the flexibility of the blade prevents tearing of the joint tape in the corners



PATCH FOR REPAIRING PLASTERBOARD

Ref : 505030

EAN : 3479135050308

>> Self-adhesive patch for effective, long-term repair of holes and cracks in plasterboard.



- >> Fast
- >> Easy to use
- >> Sustainable results



USE :

1 Clean the area to be repaired and sand lightly

2 Remove the adhesive part of the patch

3 Glue the patch so that the hole is completely sealed. Press firmly.

4 Cover patch with plaster. Allow to dry, then sand. Repeat if necessary.



STAINLESS STEEL TROWEL

- >> Stainless steel blade : without leaving rust stains
- >> Bimaterial handle

Dim - cm	Round 20	Round 22	Square 20	Cat tongue 16
Ref	330206	330226	331206	332166
EAN 347913+	3302065	3302263	3312064	3321660



TWO-HANDED SPREADER

- >> Ergonomic plastic handle : enables the use with ones or two hands

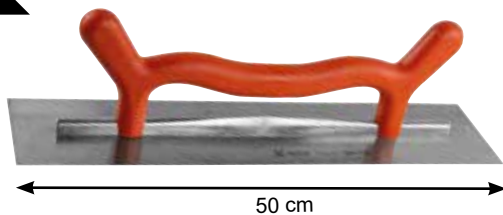

Dim - cm	50 x 12	50 x 12 beveled
Ref	232021	232031
EAN 347913+	2320213	2320312



ONE-PIECE SPONGY FLOAT

Ref : 317040
EAN : 3479133170404

- >> Recommended for lightweight plasters
- >> 18 mm orange sponge
- >> 14 x 29 cm



KEYHOLE SAW

Ref : **832938**
 EAN : 3479138329388

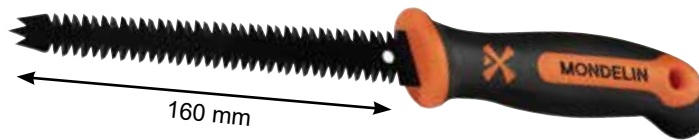

- >> Saw for cutting plasterboard, wood, PVC, areted concrete.
- >> Double teeth for multidirectional cutting
- >> Triple bevel teeth for efficient cutting
- >> Tapered trident tip for easy, precise drilling
- >> Ergonomic bimaterial handle



Textile sheath included to avoid injuries with the blade

DRYWALL CUTTER

Ref : **103108**
 EAN : 3479131031080

- >> Blade length : 25 mm
- >> Blade thickness : 0,7 mm
- >> With locking function



Spare blades x10
 Ref : 103198
 EAN : 3479131031981

DRYWALL EDGE PLANER

Ref : **502610**
 EAN : 3479135026105



- >> For chamfering the edges of plasterboard to make it easier to apply joint tape
- >> For edges of 7 mm



Spare blades x5
 Ref : 502638
 EAN : 3479135026389

DRYWALL RASP PLANE

Ref : **502530**
 EAN : 3479135025306



- >> To plan the edges of a plasterboard after cutting
- >> 255 mm replaceable blade



Spare blade x1
 Ref : 502529
 EAN : 3479135025290

DRYWALL RASP PLANE POCKET SIZE

Ref : **502560**
 EAN : 3479135025603



- >> To plan the edges of a plasterboard after cutting
- >> Compact, ultra-lightweight pocket format
- >> 140 mm replaceable blade



Spare blade x1
 Ref : 502559
 EAN : 3479135025597

NEOCUT PLASTERBOARD HANDSAW

Ref : **831700**
 EAN : 3479138317002

- >> 7 TPI, special teeth for plaster cutting
- >> With space to evacuate plaster

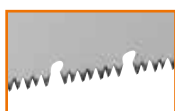

Magnetic blade protection system



MONDELIN



AVIATION SNIP

Ref : **503328**

EAN : 3479135033288

- >> For cutting metal profiles, rails, furrings, uprights, reinforced strips
- >> Excellent cutting quality



PROFILE STAPLING PLIERS SINGLE-HANDED

Ref : **503348**

EAN : 3479135033486



- >> Allows profiles to be crimped quickly and securely
- >> 1-hand operation thanks to its lever-action handle system

PROFILE STAPLING PLIERS

Ref : **503208**

EAN : 3479135032083



- >> Allows profiles to be crimped quickly and securely
- >> Use with 2 hands

NIBBLER SHEARS

Ref : **503108**

EAN : 3479135031086



- >> For cutting metal up to 1.2 mm thick cleanly, without jaggings or distortion
- >> With integrated chip cutter and chip protection

KNIFE FOR INSULATION MATERIALS

- >> For cutting glass and rock wool, hemp, linen, polystyrene and wood fibers.
- >> A blade with double teeth: saw-shaped for hard materials and wave-shaped for soft materials
- >> Bimaterial, symmetrical handle
- >> Textile sheath for safe transport



Dim L - cm	28	36
Ref	830560	830570
EAN	8305603	8305702
347913+		



LEVPANO® I

Ref : 513000
EAN : 3479135130000



LEVPANO® EVOLUTION



Watch our videos on how to use, assemble and change cables

OUR GUARANTEES

- >> Complies with European standard **CE** and directive 2006/42/CE
- >> Compliance examination by SOCOTEC
 - >> Each Levpano is individually assembled and tested
- >> Delivered pre-assembled

3 POSSIBLE LAYOUT

Horizontal up to 4.50 m
Maximum height with extension, 3.50m without extension



Installation under slopes up to 3.50m
Max. mast height



Vertical installation up to 5.90 m
max. height with a 3m plate. Mast height at 4.50m with extension, 3.50m without extension



LATEST DEVELOPMENTS



>> Improved column sliding for less friction and greater fluidity



>> 2 off road transport wheels, 10 cm in diameter, for better rolling on uneven terrain



>> 2 non-slip intermediate steps to reduce fatigue at the end of the day



>> 2 platforms with anti-slip coating, rounded edges and corners, FSC-certified mixed



>> 4 wheels with brakes



GUARANTEED SAFETY

Safety system with two cables :

- >> 1 working cable
- >> 1 anti-fall safety cable



QUICK INSTALLATION

>> Ultra-fast Clip & Go system: quick locking and unlocking of arms and feet in a single movement.



USE THE ROTATION PLATE TO SWITCH FROM UNDER SLOPES OR VERTICAL MODE

>> The head rotates with a simple pin, so there's no need to dismantle it



RETRACTABLE PADS

>> They hold the plate, and when they reach the ceiling, they retract to wedge the plate against the previous one without any gap.



2 ANTI-SLIP PLATFORMS

on which you can climb to fix a board.

- >> Resistant to 150 kg - validated by Socotec



WEDGED AND PROTECTED PLATE

>> 8 non-slip pads provide excellent plate support



REMOTE HANDLE

>> The guide handle is separate, giving the user greater visibility and control.

>> This also avoids having your head under the Levpano® when descending.

LEVPAÑO® TOOL HOLDER

Ref : 513100

EAN : 3479135131007



**NEW
2024**

>> Keeps screwdriver and screws close at hand when working on platforms

>> Fits all Levpano® models, even previous generations

>> Metal frame for strength and plastic interior for lightness

>> Rigid and stable: does not become unbalanced even with all the tools on it

>> Does not interfere with standing on platforms

>> Rounded edges to prevent injury

>> Removable



PLASTERBOARD TROLLEY WITH 2 WHEELS

Ref : 500550
EAN : 3479135005506

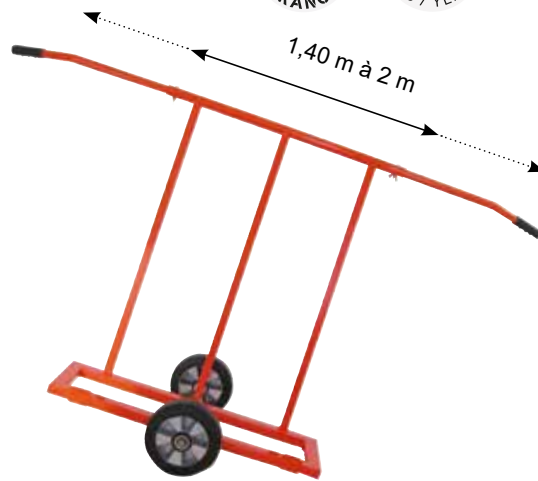

- >> 2 rubber wheels
- >> 2 swivel telescopic handles



PLASTERBOARD TROLLEY WITH 4 WHEELS

Ref : 500560
EAN : 3479135005605



- >> Foldable
- >> 4 rubber wheels, 2 of which are equipped with pivot and rolling locks
- >> High stability



3RD HAND QUICK SUPPORT ROD

Ref : 504810
EAN : 3479135048107

- >> For securing the plasterboard during transport and attachment in tight places
- >> Fast and precise adjustment
- >> With a safety lock
- >> Approved payload of 80 kg at 90° and of 30 kg at 55°



PLASTERBOARD POSITIONING AID

Ref : 502050
EAN : 3479135020509

- >> Helps to fix the plasterboard on the metal framework
- >> The work can be done by only one person





WATCH THE VIDEO :

AXIS HAND TRUCK

Ref : 601020
EAN : 3479136010202



ULTRA-TICK AXLE
4mm thick
UNTWISTABLE

- >> Puncture proof wheels Ø 250 mm
- >> Loading bucket fixed or folded
- >> Closed handles for different positions
- >> Horizontal loading possible

USEFUL LOAD

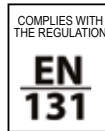

Complies with the regulation
CE, Directive 2006/42/CE

Spare wheel x1
Ref : 601028
EAN : 3479136010288

TROLLEY *Swift*



- >> 4 wheels with brakes
- >> High mobility: 4 wheels 360° rotatable
- >> Non-slip plywood with a thickness of 18 mm
- >> Rounded corners and edges
- >> 2 holes for transport

TROLLEY WITH HANDLE

Ref : 114370
EAN : 3479131143707

- >> Foldable, retractable handle, does not protrude when folded up
- >> 7,8 kg
- >> Board: 80 x 50 cm



HANDLING TROLLEY

Ref : 114300
EAN : 3479131143004

- >> Light 3,3 kg
- >> Board: 57,5 x 29 cm



WATCH THE VIDEO :

WORKBENCH
 Ref : 500700
 EAN : 3479135007005

Thales



FOLDING WORKBENCH WITH NON-SLIP TRAY

- >> 60x80 cm non-slip tray with:
- >> 2 clamp locations
- >> 1 real stainless steel ruler engraved and integrated into the tray
- >> 1 space for screws and 5 slots for screwdrivers
- >> 1 cutting zone for threaded rods and small tubes
- >> 3 adjustable heights 75, 80 and 85 cm
- >> Ultra-compact: folded only 5 cm thick
- >> Robust construction: Steel tubes, robotic welding

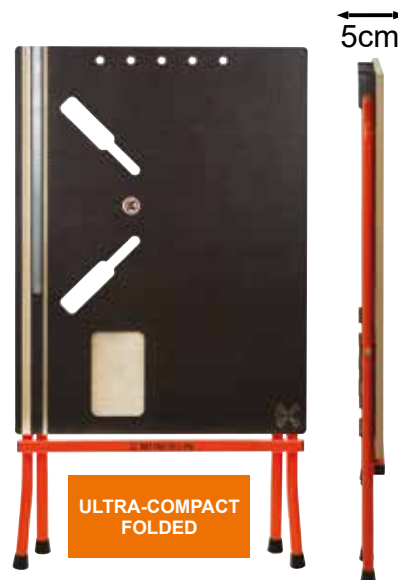

ONE HANDED CLAMP



- >> Simple one-handed using
- >> Clamping power: 150 kg
- >> Durable nylon and fiberglass head
- >> Hardened steel rod

Maximum distance - cm	15	30	45
Ref	308110	308120	308130
EAN 347913+	3081106	3081205	3081304



>> Quick "reversible" clamping for part separation



ALUMINIUM STEPLADDERS

For professionals

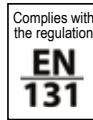

NEW

Integrated aluminium tool holder to keep your tools always at hand. Unbreakable.



NEW

XXL access ramp to make the climb safer and provide comfort



NEW 2024



>> Wide and deep 37 x 9 cm cast aluminum grating steps



>> Storage surface 320 x 360 mm to keep your tools or paint bucket

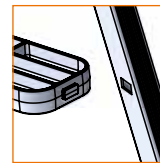

>> Robust assembly of the steps manufactured by robotic welding



>> Easy transport thanks to the ribbed handle



>> Non-slip glides and a flare for greater stability

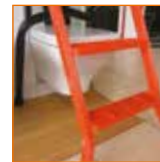

>> Elevated rear rail in order to place the ladder over obstacles like toilets

Height of the platform - cm	70	90	110	140
Number of steps including the platform	3	4	5	6
Max. work height - cm	270	290	310	340
Height folded - cm	70 x 151 x 19	70 x 174 x 19	70 x 203 x 19	70 x 229 x 19
Height unfolded - cm	137	159	182	205
Weight - kg	10	11,2	12,5	13,7
Wheelbase - cm	86 x 70	105 x 70	125 x 70	144 x 70
Ref	201950	201960	201970	201980
EAN 347913+	2019506	2019605	2019704	2019803



70 cm
2 steps
+ platform



90 cm
3 steps
+ platform



110 cm
4 steps
+ platform



140 cm
5 steps
+ platform



STEP STOOLS MULTI

Ref : 201830
EAN : 3479132018301

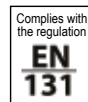

>> 1 single tool = 4 uses



STEPSTOOL with tool holder



TRESTLES



WORKBENCH



CUTTING SUPPORT

WATCH THE VIDEO :

PATENTED CLIP & GO SYSTEM
Quick adjustment of the swivel arm

- >> Height of the platform 47 cm
- >> Folded : 1040 x 705 x 170 cm
- >> Weight : 10 kg



ALUMINIUM STEP-STOOL

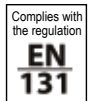

Extra wide aluminum grating steps. Easy to clean.



ROBUST AND LIGHT

- >> 2 mm thick aluminum profiles
- >> Easy folding and transport
- >> Lock in opened position for a safe use
- >> Easy transport thanks to the handle

Dim	70cm	90cm
Ref	201700	201710
EAN	2017007	2017106
347913+		



NINJA PLATFORM

Ref : 500610
EAN : 3479135006107



>> Platform 93 x 40 cm



>> Lock of the guardrail and feet for maximum protection



- >> Quick assembly in only 1 minute
- >> For intensive use
- >> Total width of 69 cm: transport through a door without folding the platform
- >> Wide grating steps
- >> Weight: 29,5 kg



7 WORKING HEIGHTS



260 / 265 / 270 / 275 / 280 / 285 / 290 cm

EASY TRANSPORT



Only 3 pieces

ALUMINUM PLATFORM



ROBUST AND LIGHT

- >> Light platform, easy folding and practical transport
- >> Aluminum grating steps: wide, deep, slip-resistant
- >> Platform of 125 x 42 cm - Height 49 cm
- >> Work height: 249 cm
- >> Transport handle
- >> Weight: 9 kg (without tool holder)

Dim	125x42 cm	125x42 cm +tool holder
Ref	500510	500513
EAN 347913+	5005100	5005131

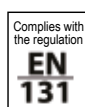

>> Platform with tool holder

NEW 2025

- >> New 140 cm height
- >> All sizes are available with a self-closing gate:
 - The platform is the same
 - Only the guardrails change. Spring-loaded, they close automatically.

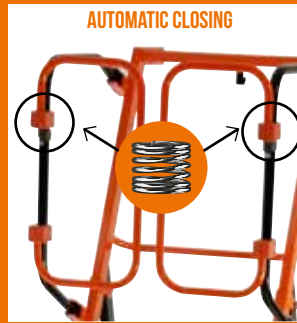

WATCH THE VIDEO :

OPTIMUM MOBILITY



>> **Spindle wheels**
Moving without lifting. Pushing with your feet possible.



>> **Inner wheels**
Positioning as close as possible to the wall.

GUARANTEED SAFETY



>> **Hinged guardrail**
Much more convenient than a strap or chain



>> **Grating steps**
Deep, slip-resistant and easy to clean. Robust shape.



- 50 cm**
1 step + platform
- 70 cm**
2 steps + platform
- 90 cm**
3 steps + platform
- 110 cm**
4 steps + platform
With stabilizers
- 140 cm**
5 steps + platform
With stabilizers

	50	70	90	110	140
Number of steps including the platform	2	3	4	5	6
Max. work height cm	250	270	290	310	340
Wheelbase - cm	66 x 88	69 x 107	81 x 126	132 x 145 stabilizers deployed	165x195 stabilizers deployed
kg	15	16,8	17,5	21	23
Dimensions folded - cm	66 x 167 x 26	69 x 193 x 26	81 x 219 x 26	86 x 245 x 26	275 x 97 x 26
Ref	202100	202110	202120	202130	202140
EAN 347913+	2021004	2021103	2021202	2021301	2021400
Ref with automatic guardrails	202150	202160	202170	202180	202190
EAN automatic guardrails 347913+	2021509	2021608	2021707	2021806	2021905



OPTIONAL :



Crane ring
2 rings to screw on (screws included)
Ref : **202103**



Bucket holder
To keep your paint bucket close (comes with a strap to secure the buckets)
Ref : **202102**



In compliance with decree 2004-924

AN INNOVATIVE CONCEPT

- >> Modul'Air platforms can be combined to suit all site configurations
- >> They allow you to work safely at height on large surfaces.

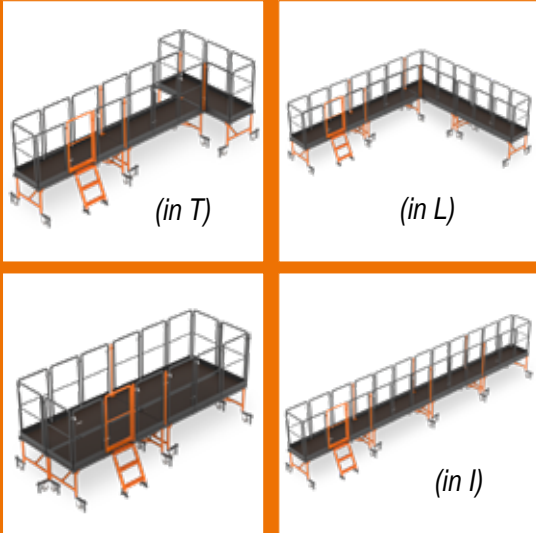

>> 190x60 cm platform in non-slip plywood



MAIN MODULE = 1 platform + 1 access step + 1 gate + 7 guardrails + 1 transport tray
Total weight : 84kg

COMPLEMENTARY MODULE = 1 platform + 6 guardrails + 2 connecting posts + 2 connecting keys + 1 transport tray
Total weight: 71kg



>> Platforms are easily linked together using connecting posts.



>> 4 360° wheels with brake + stabilizers, ultra-quick to set up with Clip&Go system.



>> Easy to transport thanks to a transport cart that allows all components to be moved in a single operation.



>> Max. working height: 3m.

Capacity	Main module	Complementary module
Ref	500800	500810
EAN 347913+	5008002	5008101



Regulation
NF 93-520



TELESCOPIC LIGHT

Ref : 865070

EAN : 3479138650703

NEW
2024

FLASH



- >> Telescopic tripod lamp with 2 swivel heads
- >> Robust aluminum design
- >> Ultra-compact when closed, with handle for easy transport
- >> When closed, lamps are perfectly protected for longer life
- >> Deploys very quickly in just 5 seconds
- >> With telescopic arm that extends up to 2 m
- >> Dimensions folded : 120 x 120 x 890 mm



- >> Heads can be rotated independently through 360°.
- >> 2 types of light: hot or cold



- >> Operates on 4000mAh Li-ion battery - 7.3V
- >> Charger: 8.4V 3A
- >> 3 wattages: 500 / 1500 / 5000 lumens with corresponding operating times of 5 h / 2.5 h / 1 h
- >> Operates at medium power when recharging from the mains
- >> IP54 protection: splash-proof and dust-proof
- >> Complete loading time: 6 h



- >> Carrying case included



4,5kg



MONDELIN



EQUIPEMENT

>> MONDELIN PRODUCTS ARE COMPLEMENTED BY THE MOB RANGE OF FORGED TOOLS.

MOB IS A FRENCH BLACKSMITH BASED IN THE LOIRE REGION (42).

The original profession of forging allows MOB to offer forged tools (hammerword, cutting tools, bars, bolt cutters, etc.) but also a significant range in trowels and earthmoving.



RELIABLE TOOLS SINCE 1920

MOB, a century-old French brand, designs and manufactures hand tools.

In addition to the factory in France, Mob has a factory in Europe for mason's pins and chisels, mason's peg...



HAND SAWS



NEO CUT

- >> Hardened teeth
- >> Triple-bevel sharpening
- >> Ergonomic bimaterial grip
- >> 1 mm thick blade



Protected teeth

- >> Magnetic teeth protection, very quick to replace
- >> Protects hands
- >> Safer and more durable



UNIVERSAL SAW

>> 7 teeth per inch



Dim. cm	Nb. of teeth per inch	Ref	EAN 330380+
40	7TPI	6320400001	0012684
45	7TPI	6320450001	0012691
50	7TPI	6320500001	0012707

THIN-CUTTING SAW

>> 11 teeth per inch



Dim. cm	Nb. of teeth per inch	Ref	EAN 330380+
40	11TPI	6321400001	0012721
45	11TPI	6321450001	0012738
50	11TPI	6321500001	0012745

SCULPTOR'S CHISEL

Ref : **7020201201**
EAN : 3303807020293



- >> Hornbeam handle
- >> Precise striking thanks to flat tip. Reinforced ferrule to prevent mushrooming and splintering.
- >> Flat surface prevents tool from rolling away
- >> Angular-section assembly prevents the silk from twisting in the handle
- >> Forged blade in high-carbon chromium steel



TOOL BOX TEXTILE CLOSED BAG

Ref : **9576000001**
EAN : 3303809004192

- >> 250 x 440 x 360 mm
- >> Large volume: 37,5 L
- >> Load capacity: 35 kg



CARPENTER'S HAMMER X STRIKER

Ref : **0407000001**
EAN : 3303800003415

- >> Forged 1 piece
- >> Fully polished
- >> Elastomer handle
- >> Profiled head
- >> Magnet pad



CARPENTER'S CHISEL

Ref : **7035300001**
EAN : 3303807035082

- >> Steel sharpenable on cutting edge
- >> Exclusive safety head





EARTHWORK SHOVEL

- >> Pointed tip for better penetration
- >> Constant sheet thickness 2mm +/- 0.2mm
- >> 2/3 heat treatment: 45-50 HRC hardness in the working areas and less hardness near the bushing to avoid any risk of breakage
- >> Designed for good balance in the hand: does not rotate



Pelle 27cm	Without handle	With PEFC wood handle
Ref	6380270010	6380270201
EAN 330380+	6380015	9515919



PICK

- >> High-carbon steel pickaxe C45 carbon steel
- >> Hardened tip and cutting edge



2.5kg	Without Handle	With PEFC wood handle
Ref	6384250010	6384250201
EAN 330380+	6384020	9516121



BIG MUTT SCRAPER

Ref : **0114010000**
EAN : 4016134005152

- >> Forged steel tool of 175 x 365 mm
- >> Thick beveled and resharpenable blade
- >> Hard wood handle : 1,37 m of length and 37 mm of diameter



MICRO SHOVEL - MULTIFUNCTION

Ref : **0114010020**
EAN : 4016134005886

- >> Compact: for all uses where the handle can get in the way: emptying bags, filling concrete mixers, working at height, etc.
- >> Fits in the trunk of a car
- >> Fiberglass shaft
- >> Comfortable bi-material handle grip
- >> Provided with edges in order to avoid the damage of shoes

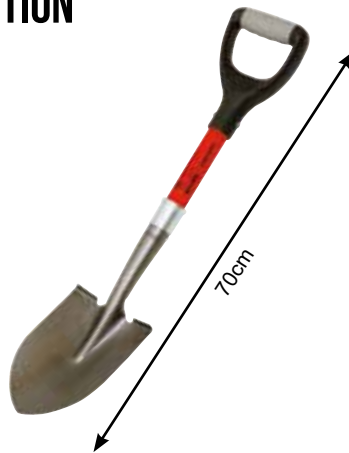

MASON TAMPER - SQUARE

Ref : **0144150201**
EAN : 3303800007970

- >> For damping floors
- >> Cast iron with wooden handle
- >> Also practical around concrete poles
- >> Dimensions 150x150 mm



COLOR TRACE

TEMPORARY MARKING

- >> Reliability: no leaks thanks to exclusive safety cap
- >> Good paint usage: can empties to 98% capacity

TRACE



	Blue	White	Red	Yellow	Orange	Green
Ref	6264500001	6264500101	6264500201	6264500301	6264500401	6264500501
EAN 330380+	6002788	6002801	6002757	6002764	6002771	6002795





BOLT CUTTER 600MM

Ref : **0515070610**
 EAN : 3303800515017



MOB INNOVATION
 Off-center arm axis for wider opening

TUBULAR ARMS

- >> Excellent cutting High-strength steel Chrome Vanadium Molybdenum
- >> Hardened and forged blades for a long lasting quality
- >> Simple gap adjustment via 1 eccentric screw
- >> The change of the blades is done by 2 screws

CROWBAR

Ref : **0152150001**
 EAN : 3303800152038



Length : 1,5 m

- >> One tip side for digging
- >> One flame side for cutting and prying
- >> End hardness : 55 HRC (+/-3)



Manufactured in Le Chambon Feugerolles (42)

RUSSIAN PINGERS

Ref : **6350250001**
 EAN : 3303806350032



250 MM

- >> High cutting quality
- >> Forged, induction-hardened and polished head

BENDING BAR



- >> For bending concrete reinforcing bars
- >> One-piece forged and hardened tool

Dim - mm	6 x 8	10 x 12
Ref	0183060601	0183100601
EAN 330380+	0183018	0183032

WIRE TWISTER DRILL

Ref : **6541001001**
 EAN : 3303806000722

- >> Used to quickly bond reinforced concrete reinforcement
- >> Fast, professional ratchet



31CM

LOOP TIES

Ref : **6540120101**
 EAN : 3303806002948



x 1 000

- >> Bunch of 12 cm annealed tie
- >> For use with automatic binder
- >> Also useful for tying bags and fences



MASON'S POINTED CHISEL



- >> Hardened forged steel, sharpenable at tip
- >> Exclusive safety head



Dim - mm	300 x 16	350 x 16	400 x 18	With handle 300 x 16
Ref	7170310001	7170360001	7170420001	7170310201
EAN 330380+	7170141	7170233	7170301	7170165



MASON'S CHISEL



- >> Hardened forged steel, sharpenable at tip
- >> Exclusive safety head



Dim - mm	300 x 16	350 x 16	400 x 18	With handle 300 x 16
Ref	7171310001	7171360001	7171420001	7171310201
EAN 330380+	7171117	7171209	7171278	7171131

SAFETY HANDLE

Ref : 7311000001
EAN : 3303807311001

- >> Hexagonal: does not roll
- >> Internal shock-absorbing slats
- >> For 16 and 18 mm diameter spindles or chisels



BRICK CHISEL



- >> Superior steel quality forged hardened
- >> Resharpenable
- >> Exclusive safety head



Dim - mm	60	70
Ref	7175600001	7175700001
EAN 330380+	7175078	7175115

MASON'S PEG



- >> 100% forged jack
- >> Barley grain tip
- >> Overhead clearance
- >> Rounded multi-socket foot



Dim - mm	Square 250	Square 300	Octogonal 250	Octogonal 300
Ref	7160250001	7160300001	7164250001	7164300001
EAN 330380+	7160043	7160067	7164034	7164058

MASON'S CLAMP

- >> Forged checkered head
- >> Section 30 x 7 mm



Dim - mm	600x800	800x1000
Ref	6398600010	6398800010
EAN 330380+	6398010	6398027

MASON'S SQUARE



- >> Section 30 x 5 mm
- >> Professional precision

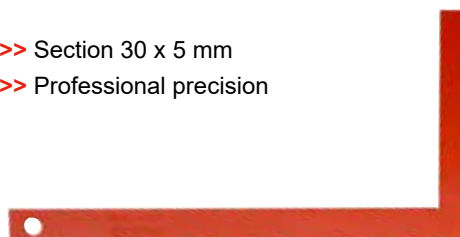

Dim - cm	60 cm	80 cm
Ref	6265060001	6265080001
EAN 330380+	6265046	6265053

WRECKING BAR POWER BAR



Dim - mm	600	900
Ref	7187600010	7187900010
EAN 330380+	7187606	7187903

- >> Oval body with strong section in the direction of effort, does not bend
- >> Wide base for perfect stability when lifting or pulling nails

+ PERFORMANCE

- >> 60% more gear ratio on the start thanks to its progressive curve. Patent.

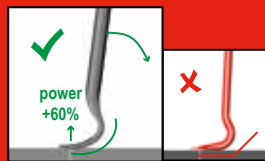

+ ACCESSIBILITY

- >> Optimized accessibility: there's plenty of room for your hand when you come up against a vertical part to be lifted
- >> Wide, tapered ends for deep insertion everywhere



WRECKING BAR

Ref : 718160001
EAN : 3303807181055



600 x 18 mm

- >> 1 heavy-duty nail puller side
- >> 1 side for leverage and stripping

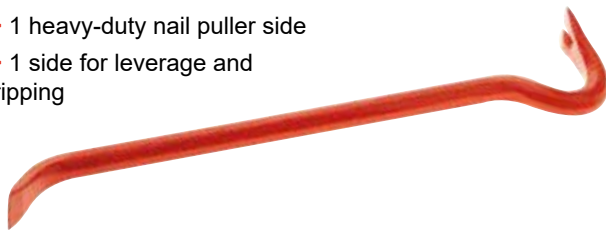

BIBER BAR

Ref : 0113010015
EAN : 4016134004995

BIBER-BAR

- >> Flat and thin for easy sliding between 2 pieces of wood
- >> 3 nail pullers to work in any situation
- >> High-strength silicon manganese steel



WORKSITE BOX

- >> Padlockable closure (Ø10mm)
- >> Removable sliding tray
- >> 90° cover opening
- >> 2 handles
- >> Thick sheet metal for high rigidity

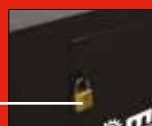

550MM
Ref : 9589010001
EAN : 3303800010253

670MM
Ref : 9589020001
EAN : 3303800010246

850MM
Ref : 9589030001
EAN : 3303800010260



ROUND EXCELLENCE TROWEL

THROUGH TANP

>> The through-bristle allows the end of the handle to be used to adjust bricks and breeze-blocks during wall assembly, without damaging the handle.

>> The striking energy is conducted by the metal rod inside the handle, which runs from the base to the forged tang.



Dim - cm	18	20	22	24
Ref	6001180001	6001200001	6001220001	6001240001
EAN 330380+	6001057	6001071	6001095	6001118

Other shapes and sizes available.



DIGRESSIVE BLADE

The blade is of decreasing thickness, for controlled flexibility.

AUTHENTIC TROWEL ROUND

>> Double ferrule

>> Professional quality



SQUARE



CAT'S TONGUE

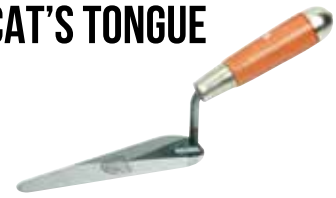

Dim - cm	18	20	22	24
Ref	6002180101	6002200101	6002220101	6002240101
EAN 330380+	6002085	6002122	6002160	6002207

Dim - cm	18	20
Ref	6007180101	6007200101
EAN 330380+	6007080	6007127

Dim - cm	14	16
Ref	6015140101	6015160101
EAN 330380+	6015054	6015092

BIMATERIAL TROWEL



>> Bi-material handle with anti-slip finger stop

>> Round, smooth handle shape for easy projecting

>> Metal base for knocking adjustment

Round - cm	18	20	22
Ref	6003180401	6003200401	6003220401
EAN 330380+	6003020	6003037	6003044

MASON'S CLUB HAMMER TRIMATERIAL HANDLE

Ref : 0136130704

EAN : 3303800004252

1,25 kg

>> Fiberglass-reinforced tri-material handle with elastomer coating for greater comfort

>> Conical shank

>> Angles cut to reduce the risk of splintering



FORMWORK HAMMER

Ref : 0478000701

EAN : 3303800478008



>> Scraping head with :

- 1 toothed side for scraping granular surfaces (stone, concrete...)

- 1 smooth side for scraping finer surfaces (plaster, sand...)

- 1 tapered nail puller

>> Fiberglass-reinforced trimaterial handle

>> Powerful leverage thanks to longer handle

CLUB HAMMER TRIMATERIAL HANDLE

Ref : 0136410701

EAN : 3303800136960



4 kg

>> Angles chamfered to reduce the risk of splintering

>> Fiberglass-reinforced trimaterial handle

>> Conical shank

INSPIRED BY YOUR CRAFT SITES



Document non contractuel

DISCOVER US



AND FOLLOW OUR NEWS ON :



www.mondelin.fr

NOVALIA SAS - 2 rue Bergognon - 42500 Le Chambon Feugerolles - France

